

SIM Card Connectors

FOR PORTABLE DEVICES

Selection Catalog

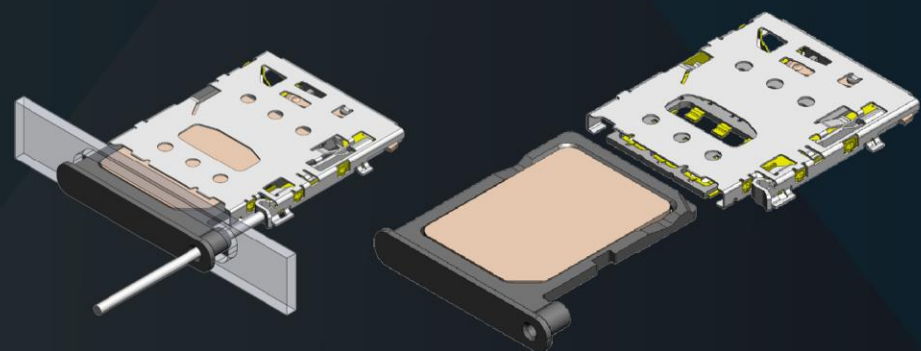

Technology to Inspire Innovation

JAE

SIM Card Connectors FOR PORTABLE DEVICES

JAE's SIM card interconnect solutions provide best-in-class reliability, performance, and miniaturization through industry leading manufacturing technology and design. Our elite line of SIM card solutions feature a large line-up of options for various card sizes and ejection mechanisms for every application.



SF56K Series



SF78 Series

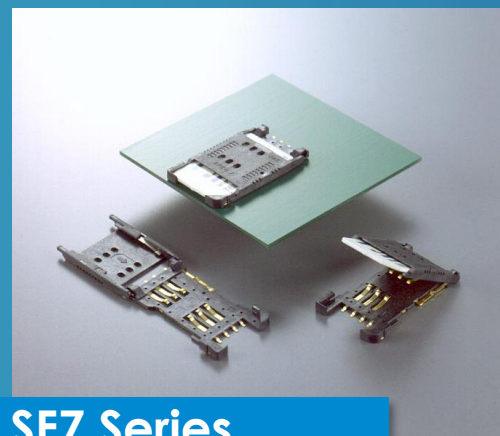

SF7 Series

SIM CARD CONNECTOR Selection Guide

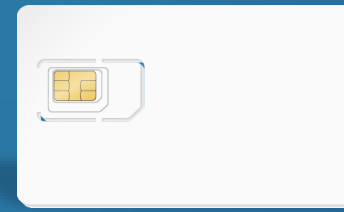

	Full	Mini		Micro				Nano			
Series	SF6	SF7	SF8 / SF9	SF15	SF53	SF56K	SF58	SF70	SF72	SF78	ST19
Photo											
Mating Type	Push button	Hinge	Push-pull tray	Hinge	Push-pull	Push-push	Pin eject tray	Pin eject tray	Push-push	Pin eject tray	Pin eject tray
Mounted Height	4.8mm	1.9 – 2.5mm	1.55, 1.8mm	1.55mm	1.45mm	1.27mm	1.3mm	1.25mm	1.25mm	1.3mm	1.3mm
Pin Count	6+2	6, 6+2	6	6	6	6+2	6+2	6+2	6+2	12+2	20+2
Durability	3,000 cycles	5,000 cycles	5,000 cycles	1,500 cycles	1,500 cycles	5,000 cycles	5,000 cycles	5,000 cycles	5,000 cycles	2,500 cycles	2,500 cycles
Features	Spring loaded push button eject mechanism for Smart Cards.	Various options for cover material and detection switch.	Compact footprint and low mounted height.	Ultra compact footprint. Easy to operate and reliable friction lock.	Bridged contact to prevent damage. Large cutout in cover for easy access.	Long card eject length. Bridged contact for reliability.	Special lock mechanism to increase tray retention force.	Designed to prevent reverse insertion of tray.	Long card eject length. Wide contact shape for high reliability.	Connection for 2 nano SIM cards at same time.	Connect 2 nano SIM or 1 nano SIM and 1 microSD card at same time.

Push Button Type
SIM Connectors

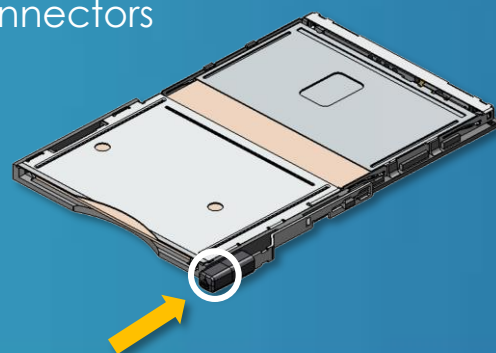

Hinge Type
SIM Connectors

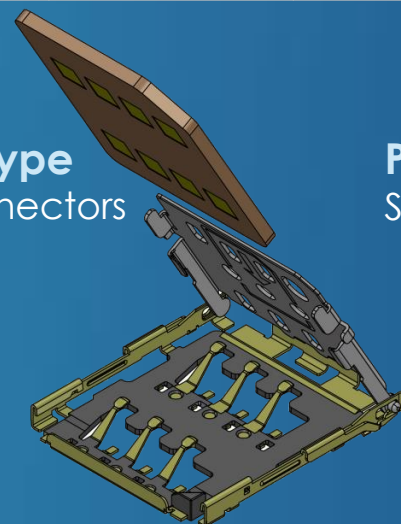

Push-push Type
SIM Connectors

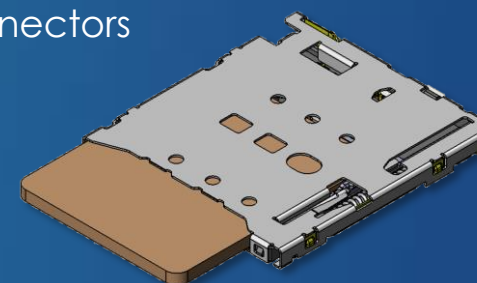

Pin Eject Tray Type
SIM Connectors

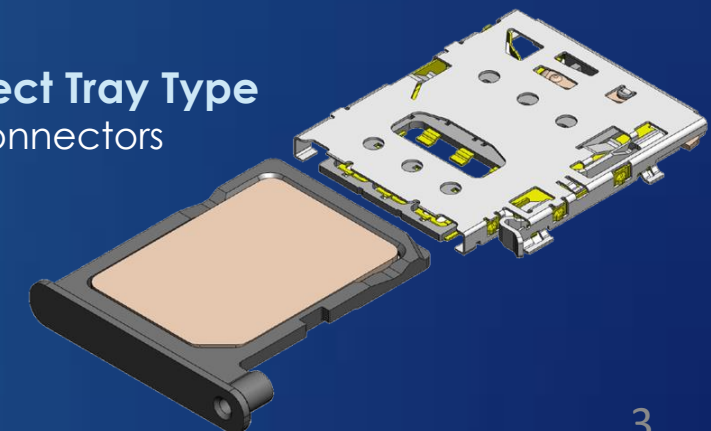

Loading Styles

PIN EJECT TRAY

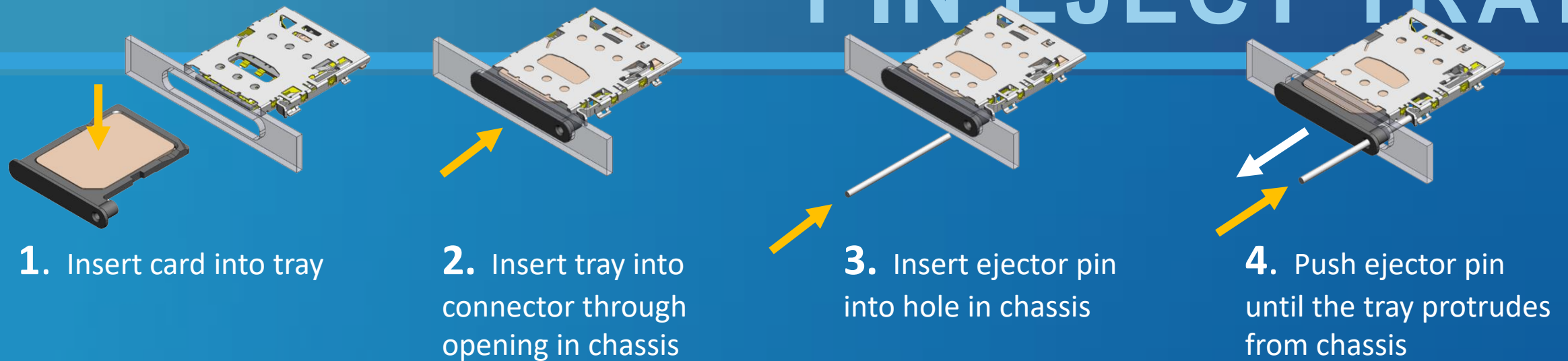

HINGE/CLAM SHELL



Loading Styles

PUSH-PUSH

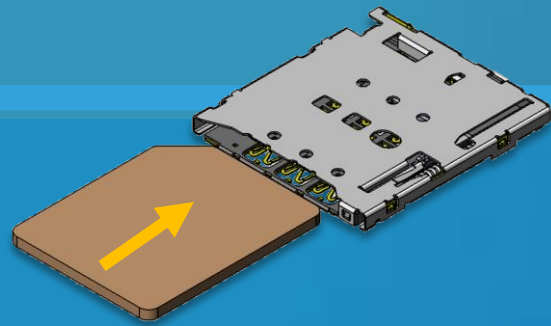

1. Push card into connector

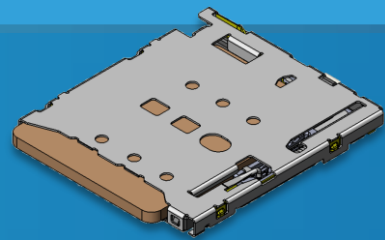

2. When card is fully inserted, connector will retain card

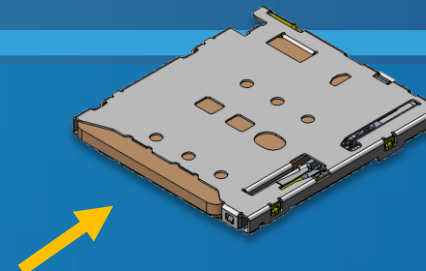

3. Push card slightly into the connector to initiate spring loaded eject mechanism

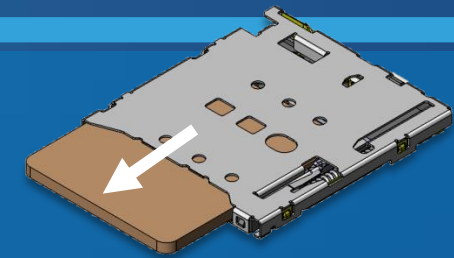

4. Spring loaded eject mechanism will push card out far enough to easily grab by hand

PUSH BUTTON

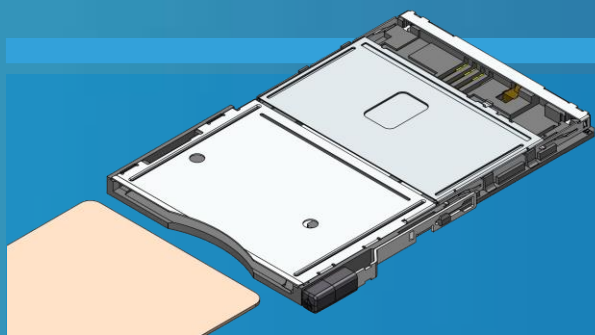

1. Push card into connector

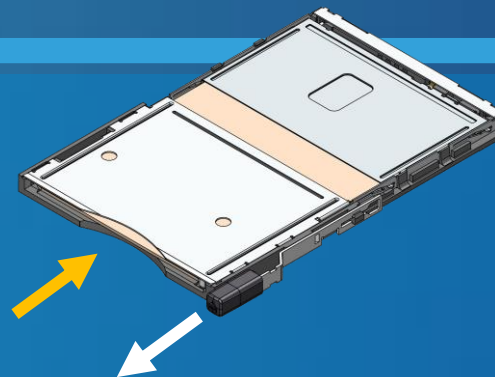

2. When card is fully inserted, push button will protrude slightly

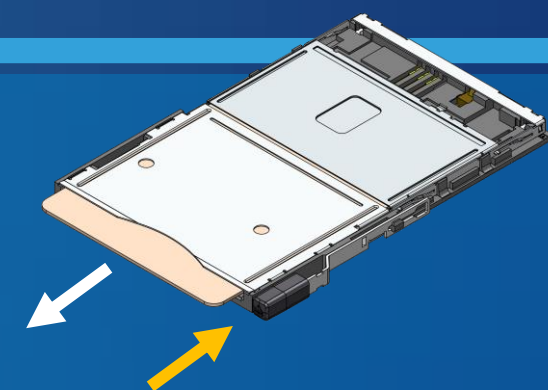

3. Push on button for the card to be ejected

Loading Styles

PUSH-PULL (TRAY)

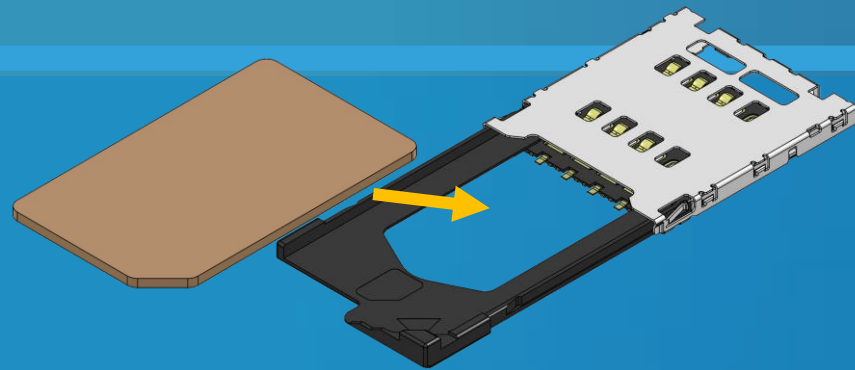

1. Place card into tray

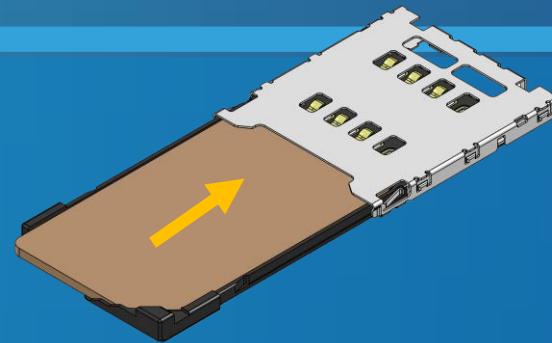

2. Push tray into connector to lock

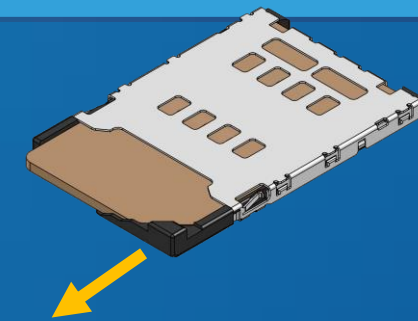

3. Pull on extended lip of tray to eject tray

PUSH-PULL

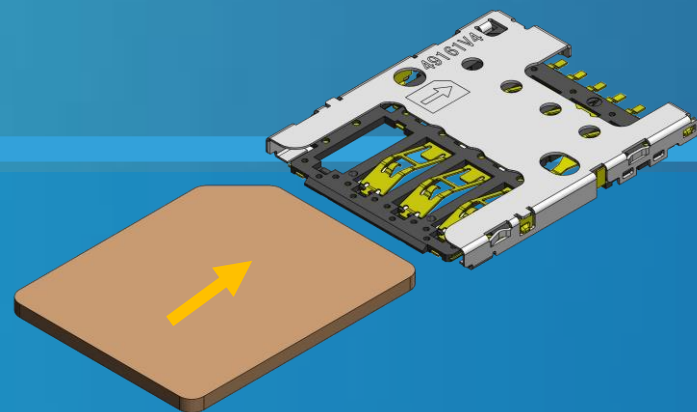

1. Push card into connector

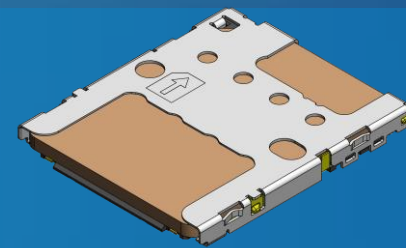

2. When card is fully inserted, card will be retained in connector

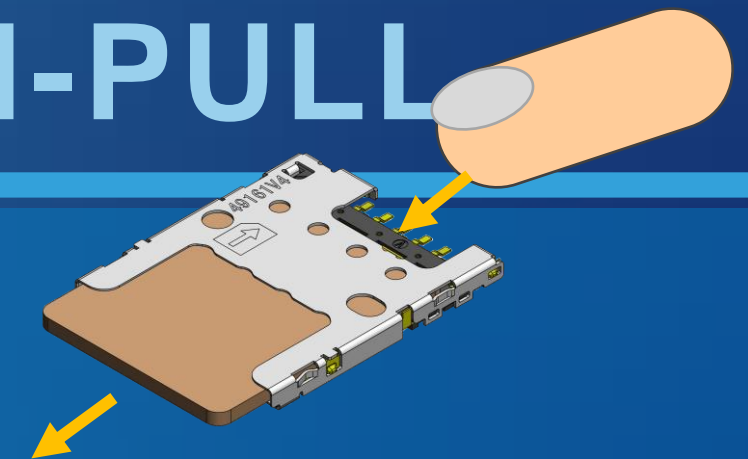

3. Push card out manually from opposite side of connector

SIM Selection Matrix

JAE offers a wide selection of SIM Card connector variations. Please reference the selection matrix below for a deeper insight into where each of our SIM card series fall in terms of size and loading/ejection structure.

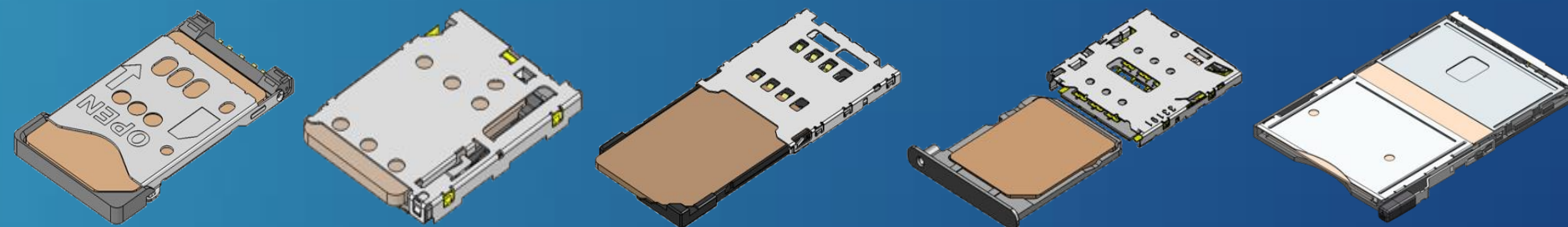

	Hinge / Clam Shell	Push-Push	Push-Pull (Tray)	Pin Eject Tray	Push Button
Full Size SIM					SF6
Mini SIM	SF7		SF8, SF9		
Micro SIM	SF15	SF56K	SF53	SF58	
Nano SIM		SF72		SF70, SF78, ST19	

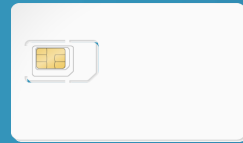

Features

- Push button eject mechanism
- Mounted Height: 4.8mm
- Card retention lever activates after card is fully inserted
- Compatible with all Smart Cards
- Card detection switch included (normal open)

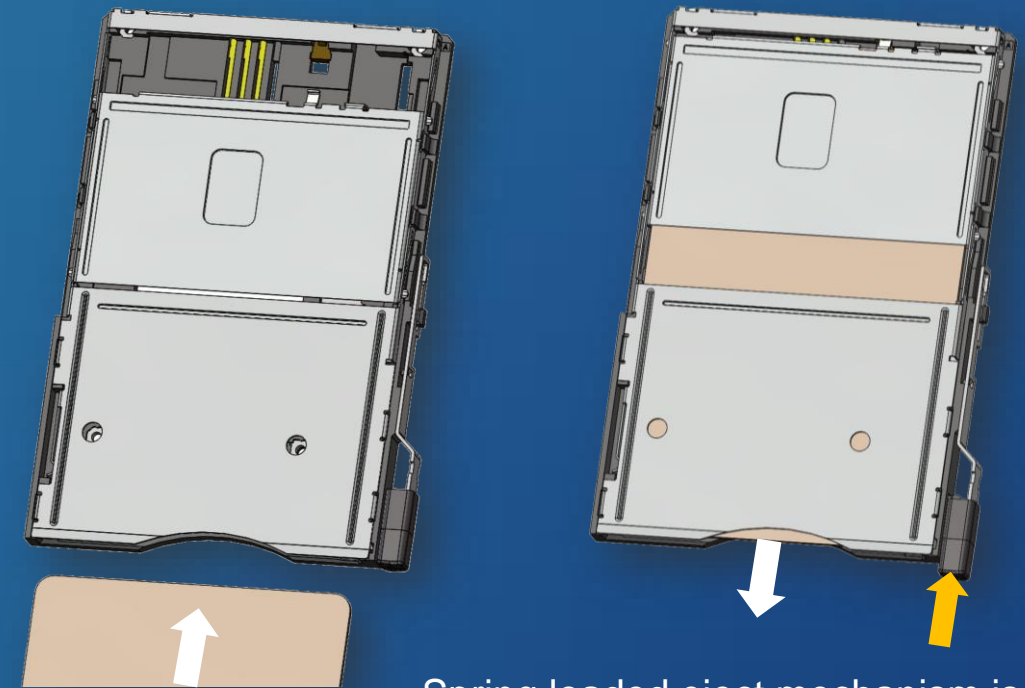

Spring loaded eject mechanism is activated by button.

General Specifications

Pin Count	6 +2 (detect switch)
Current Rating	1A
Mating Cycles	3,000
Insulation Resistance	1,000MΩ (Min)
Contact Resistance	100mΩ (switch: 1 Ω)
Operating Temperature Range	-30°C~+85°C

Materials and Finishes

Description	Materials / Finishes
Insulator	LCP (UL94V-0, Black)
Contact	Copper Alloy / Connecting area: Au (0.03μm min) over Pd-Ni over Ni Terminal area: Au flash over Ni
Nut	Stainless steel / Ni

SF7 Series



Mini

Features

- Hinge type mechanism for easy access from above
- Mounted Height: 1.9 – 2.5mm based on configuration
- Card detection switch optional (normal open)
- Cover can open a full 180 degrees without damage
- Metal or plastic cover option available

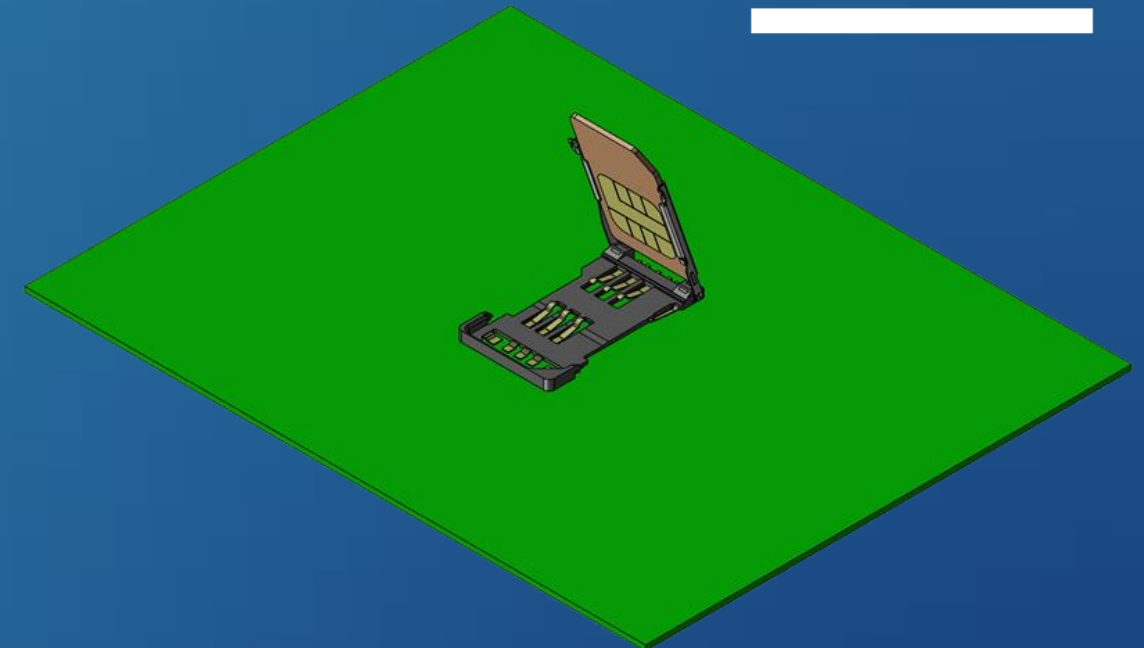

Easy to access card from above so the connector can be mounted in middle of board.

General Specifications

Pin Count	6, 6 +2 (detect switch)
Current Rating	0.5A
Mating Cycles	5,000
Insulation Resistance	1,000MΩ (min)
Contact Resistance	100mΩ (max)
Operating Temperature Range	-30°C~+85°C

Materials and Finishes

Description	Materials / Finishes
Insulator	Synthetic resin (UL94V-0, Black)
Contact	Copper Alloy / Connecting area: Au (0.5μm min) over Ni Terminal area: Au (0.03um min) over Ni
Cover	Synthetic resin (UL94V-0, Black) or Stainless steel

SF8 / SF9 Series



Mini

Features

- Push pull tray
- Mounted Height: 1.55mm (SF8) and 1.8mm (SF9)
- Clear click feeling when tray is locked
- Tray sold as separate part number

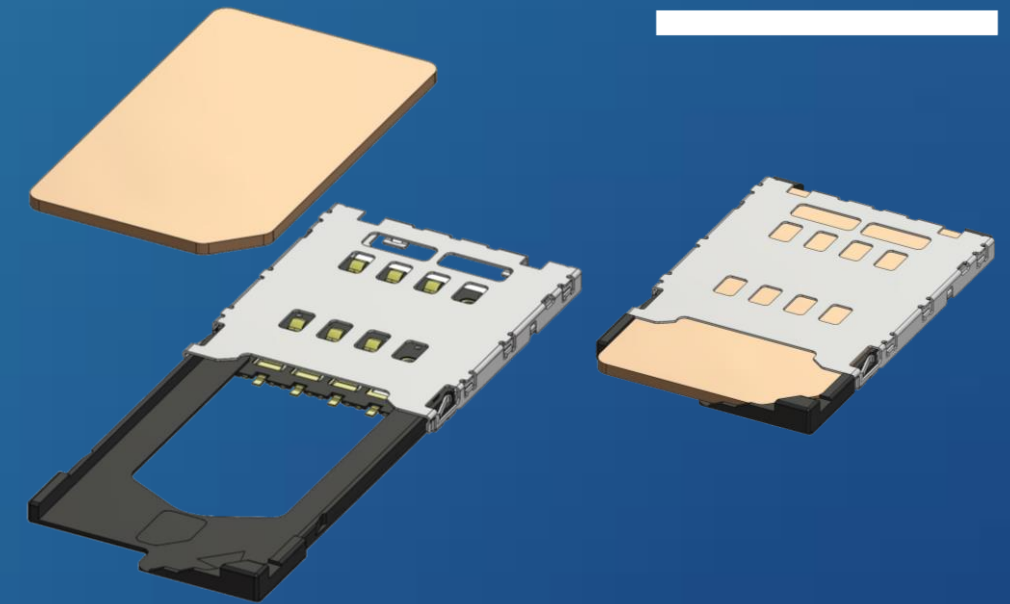

Tray does not get fully removed from connector during normal operation by user.

General Specifications

Pin Count	6
Current Rating	1A
Mating Cycles	5,000
Insulation Resistance	1,000MΩ (min)
Contact Resistance	100mΩ (max)
Operating Temperature Range	-25°C~+85°C

Materials and Finishes

Description	Materials / Finishes
Insulator	LCP (Color: Black, UL94 V-0)
Contact	Copper Alloy / Au over Ni
Cover	Stainless steel
Tray	Polycarbonate



Features

- Hinge type mechanism for easy access from above
- Stacking Height: 1.55mm
- Extremely compact footprint
- Lock and unlock symbols etched on cover for easy use
- Cover can open to 128 degree angle for easy operation

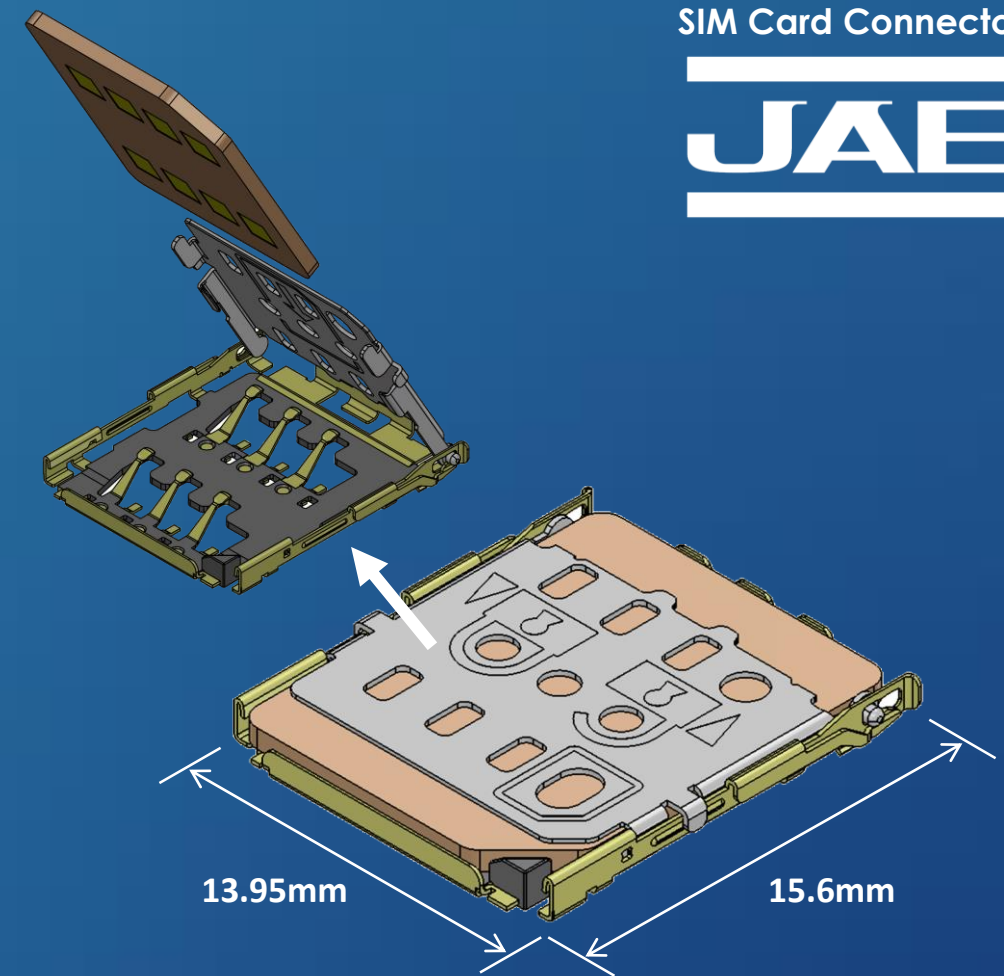

General Specifications

Pin Count	6
Current Rating	0.5A
Mating Cycles	1,500
Insulation Resistance	1,000MΩ (min)
Contact Resistance	100mΩ (max)
Operating Temperature Range	-30°C~+85°C

Materials and Finishes

Description	Materials / Finishes
Insulator	LCP (Color: Black)
Contact	Copper Alloy / Connecting area: Au (0.5μm min) over Ni Terminal area: Au (0.03um min) over Ni
Cover	Stainless steel
Frame	Copper Alloy / Au flash over Ni



Features

- User manually inserts and ejects card
- Height: 1.45mm
- Bridged contact design to prevent damage from adapter cards and off angled card insertion
- Easy to access large cutouts in cover to allow for easy removal of card

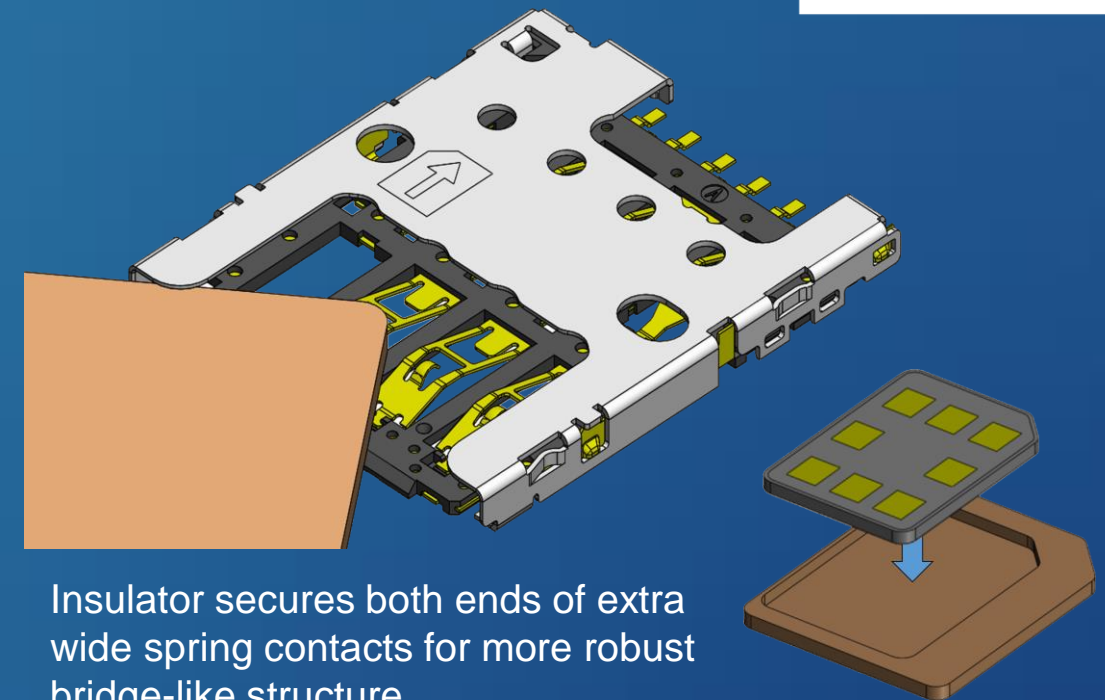

Insulator secures both ends of extra wide spring contacts for more robust bridge-like structure.

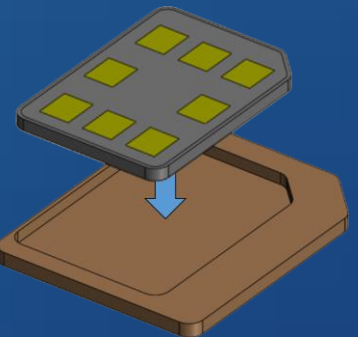

Nano to micro SIM adapter card

General Specifications

Pin Count	6
Current Rating	0.5A
Mating Cycles	1,500
Insulation Resistance	1,000MΩ (min)
Contact Resistance	100mΩ (max)
Operating Temperature Range	-30°C~+85°C

Materials and Finishes

Description	Materials / Finishes
Insulator	LCP (Color: Black)
Contact	Copper Alloy / Connecting area: Au (0.3μm min) over Ni Terminal area: Au (0.03um min) over Ni
Cover	Stainless steel / Partial Au over Ni

SF56K Series



Micro

Features

- Reliable push-push eject mechanism
- Height: 1.27mm
- Bridged contact design to prevent damage from adapter cards
- Long card eject length for easy access when removing card
- Specialized rejection mechanism for incorrect card types

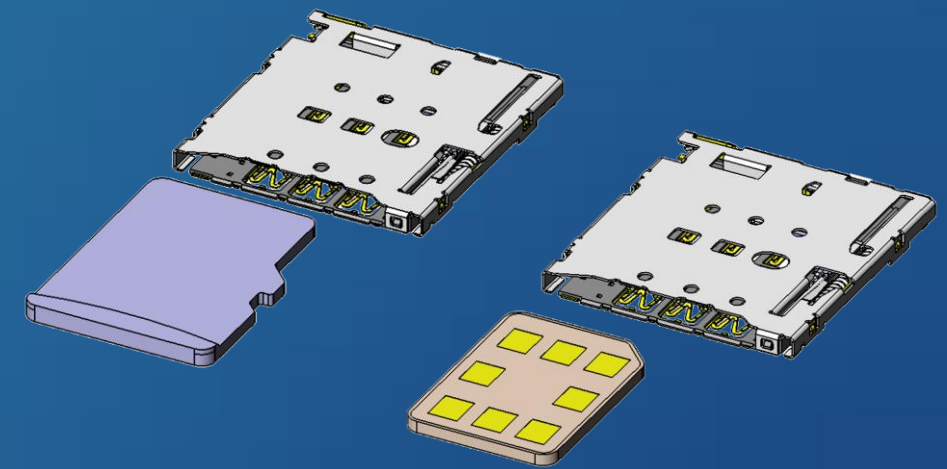

The eject mechanism can eject other card types if a user accidentally inserts a smaller card such as microSD or nano SIM.

General Specifications

Pin Count	6 +2 (detect switch)
Current Rating	0.5A
Mating Cycles	5,000
Insulation Resistance	1,000MΩ (min)
Contact Resistance	100mΩ (max)
Operating Temperature Range	-25°C~+85°C

Materials and Finishes

Description	Materials / Finishes
Insulator	LCP (Color: Black)
Contact	Copper Alloy / Au over Ni
Cover	Stainless steel / Partial Au over Ni
Frame	Copper Alloy / Au flash over Ni
Eject Bar	Nylon (Color: Black)
Eject Plate & Spring	Stainless Steel



Features

- Easy to operate pin eject mechanism
- Height: 1.3mm
- Tray detection switch included (normal open)
- Connector design prevents reverse insertion of tray
- Only reference design provided for tray

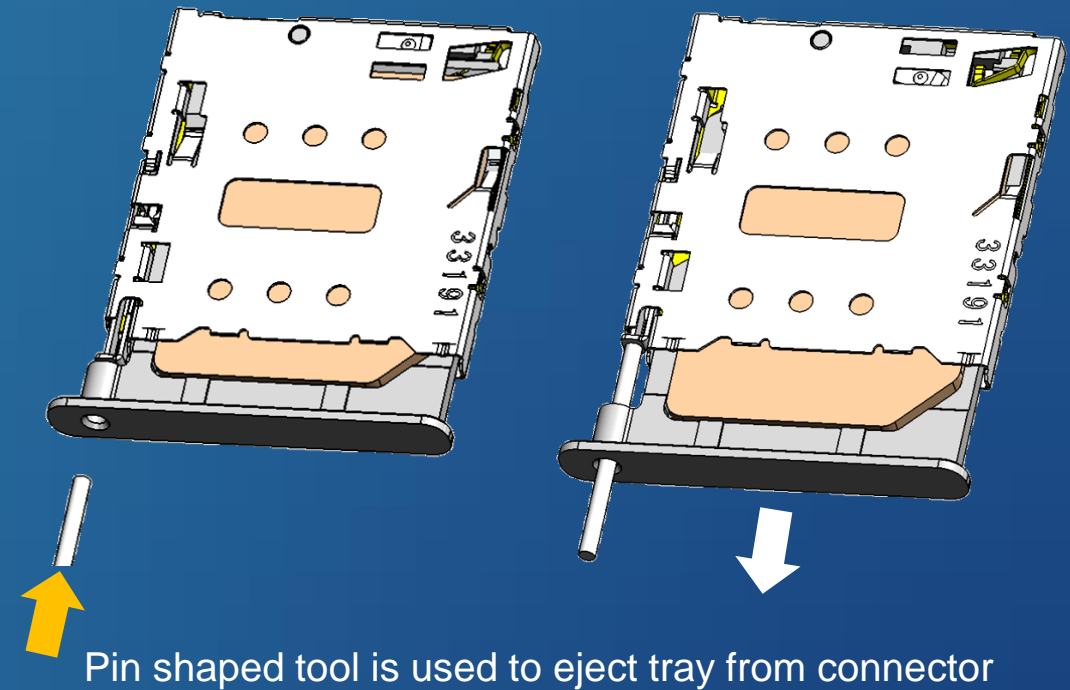

General Specifications

Pin Count	6 +2 (detect switch)
Current Rating	0.5A
Mating Cycles	5,000
Insulation Resistance	1,000MΩ (min)
Contact Resistance	100mΩ (max)
Operating Temperature Range	-40°C~+85°C

Materials and Finishes

Description	Materials / Finishes
Insulator	LCP (Color: Black)
Contact	Copper Alloy / Connecting area: Au (0.3μm min) over Ni Terminal area: Au (0.03um min) over Ni
Cover	Stainless Steel / Partial Au over Ni
Eject Lever and Bar	Stainless Steel

SF70 Series



Features

- Easy to operate pin eject mechanism
- Height: 1.25mm
- Tray detection switch included (normal open)
- Connector design prevents reverse insertion of tray
- Only reference design provided for tray

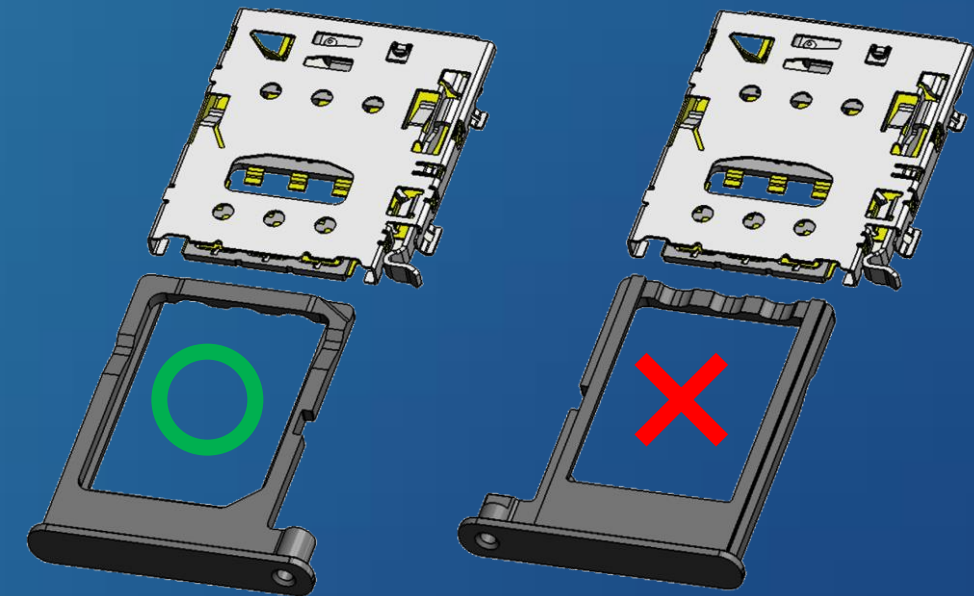

Tray and connector shape stop accidental insertion of tray upside down.

General Specifications

Pin Count	6 +2 (detect switch)
Current Rating	0.5A
Mating Cycles	5,000
Insulation Resistance	1,000MΩ (min)
Contact Resistance	100mΩ (max)
Operating Temperature Range	-40°C~+85°C

Materials and Finishes

Description	Materials / Finishes
Insulator	LCP (Color: Black)
Contact	Copper Alloy / Connecting area: (0.3μm min) over Ni Terminal area: Au (0.03um min) over Ni
Cover	Stainless Steel / Partial Au over Ni
Eject Lever and Bar	Stainless Steel

SF72 Series



Features

- Reliable push-push eject mechanism
- Long card eject length for easy access when removing card
- Height: 1.25mm
- Card detection switch included (normal open)
- Unique contact design for high contact force and robustness

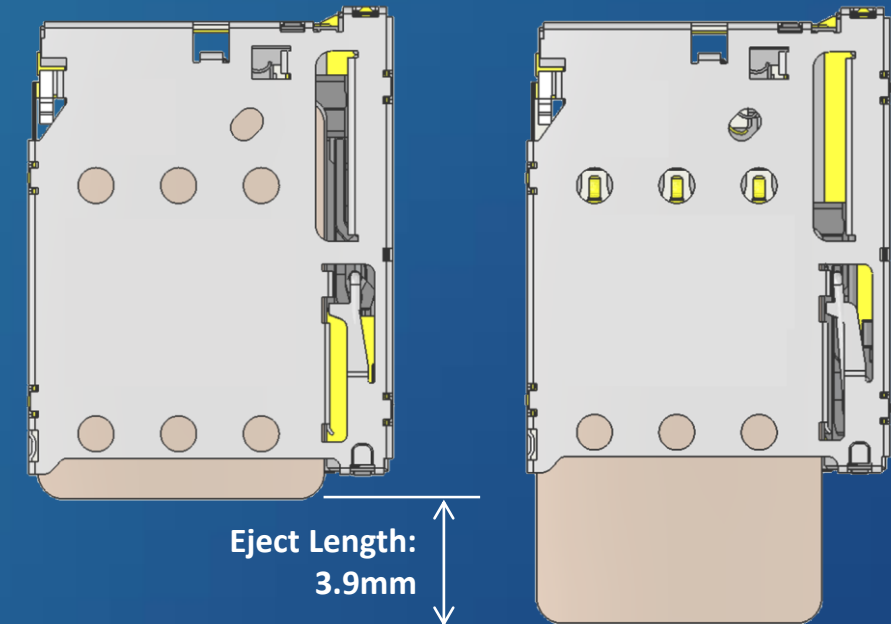

Card mated and card ejected position comparison

General Specifications

Pin Count	6 +2 (detect switch)
Current Rating	0.5A
Mating Cycles	5,000
Insulation Resistance	1,000MΩ (min)
Contact Resistance	100mΩ (max)
Operating Temperature Range	-25°C~+85°C

Materials and Finishes

Description	Materials / Finishes
Insulator	LCP (Color: Black)
Contact	Copper Alloy / Connecting area: Au (0.3μm min) over Ni Terminal area: Au (0.03um min) over Ni
Frame	Copper Alloy / Au over Ni
Cover	Stainless Steel / Partial Au over Ni
Eject Bar	Nylon
Spring	Stainless Steel

SF78 Series



Features

- Connects 2 cards at same time
- Height: 1.3mm
- Tray detection switch included (normal closed)
- Bridged contact design to improve robustness and reliability
- Only reference design provided for tray

General Specifications

Pin Count	12 +2 (detect switch)
Current Rating	0.5A
Mating Cycles	2,500
Insulation Resistance	1,000MΩ (min)
Contact Resistance	100mΩ (max)
Operating Temperature Range	-40°C~+85°C

Materials and Finishes

Description	Materials / Finishes
Insulator	LCP (Color: Black)
Contact	Copper Alloy / Connecting area: Au (0.3μm min) over Ni Terminal area: Au (0.03um min) over Ni
Cover	Stainless Steel / Partial Au over Ni
Eject Lever and Bar	Stainless Steel

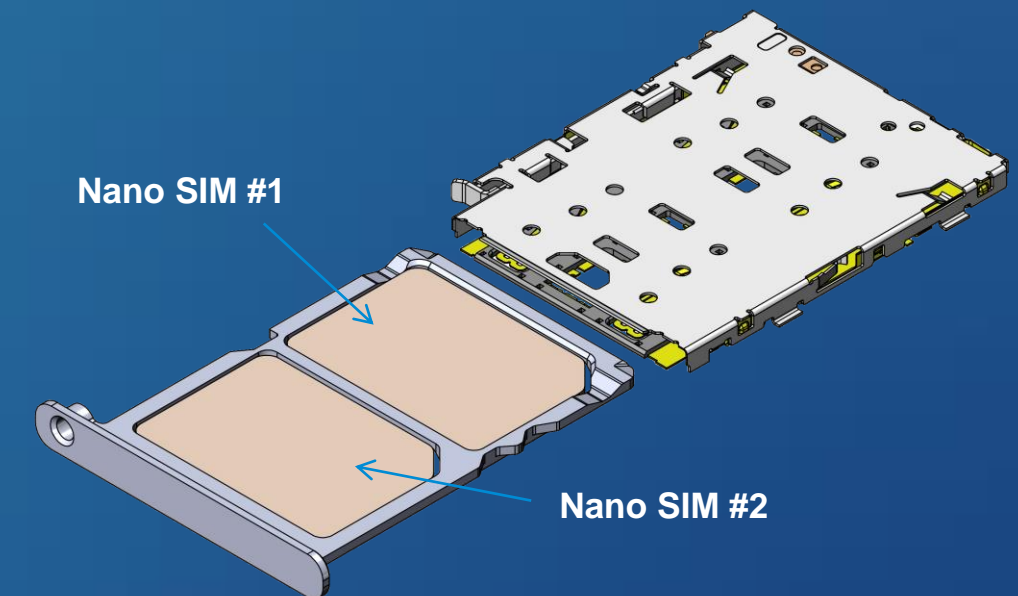

ST19 Series



Nano

Features

- Connect 2 nano SIM cards or 1 nano SIM and 1 microSD card
- Height: 1.3mm
- Tray detection switch included (normal closed)
- Bridged contact design to improve robustness and reliability
- Only reference design provided for tray

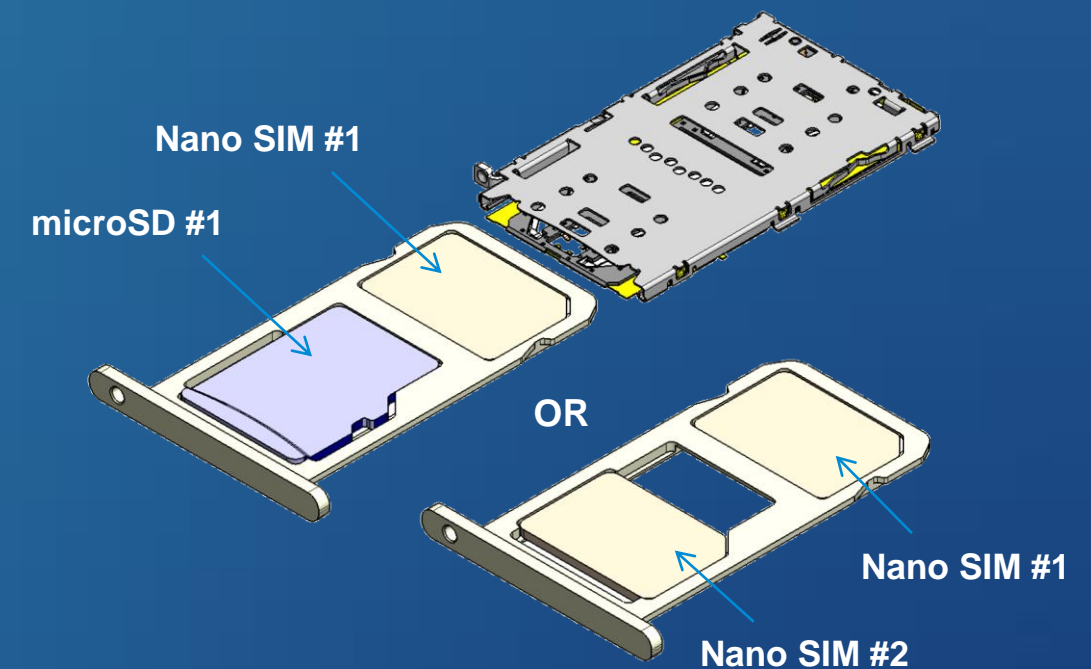

General Specifications

Pin Count	20 +2 (detect switch)
Current Rating	0.5A
Mating Cycles	2,500
Insulation Resistance	1,000MΩ (min)
Contact Resistance	100mΩ (max)
Operating Temperature Range	-40°C~+85°C

Materials and Finishes

Description	Materials / Finishes
Insulator	LCP (Color: Black)
Contact	Copper Alloy / Connecting area: Au (0.3μm min) over Ni Terminal area: Au (0.03um min) over Ni
Cover	Stainless Steel / Partial Au over Ni
Eject Lever and Bar	Stainless Steel

Portable Device SIM Card Connectors



For more information on our SIM Card connectors
please visit us online at www.jae.com/en/

Or reach out to a representative

Phone: (800) 523-7278

Email: marketing@jae.com